

# Superior protection for low-slope commercial roofs



# Build up protection

Your roof is a critical factor in the overall performance of the building envelope.

Whatever your roof type – protected membrane or conventional, low-slope, or flat – DuPont can help you design and build longer-lasting, more energy-efficient and sustainable assemblies with compatible moisture-resistant insulation, sealants and adhesives engineered to deliver superior performance.



## A history of proven performance on your side

DuPont™ Styrofoam™ Brand Extruded Polystyrene (XPS) Insulation has a long and rich heritage as a sustainable building product, advancing roofing technology and enabling architects and designers to meet essential performance targets.

## Styrofoam™ Brand XPS Insulation

*Where performance, sustainability and life-cycle cost meet job site productivity*

- Superior moisture resistance
- Long-term high R-value thermal performance for energy efficiency and savings
- Strong yet lightweight
- High compression strength (up to 100 psi) for excellent durability and damage resistance
- Long-term performance for low life-cycle cost
- Reusable in many applications to support circular economy efforts
- Compatible with green and blue roof systems
- 100% of the electricity used to make Styrofoam™ Brand XPS Insulation comes from renewable energy sources<sup>†</sup>
- Zero-ozone-depletion formula
- Certified average 20% pre-consumer recycled content through UL Environment
- Low-VOC compliance (California Title 24 standard)
- Compliant with state regulations where sold by DuPont
- Manufactured with safer-by-design BLUEDGE™ polymeric flame retardant

Lightweight and easy to handle, cut and install, Styrofoam™ Brand XPS Insulation also helps roofing contractors and crews keep their projects running smoothly, on time and on budget.

<sup>†</sup> We have purchased renewable energy credits (RECs) to offset our electricity usage since 2016.

## EPS vs. Styrofoam™ Brand XPS Insulation

**Make the better choice for your roof**

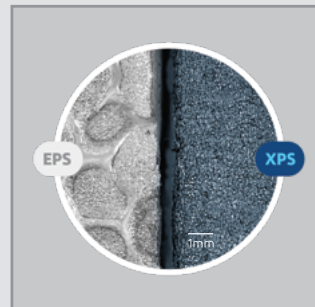

EPS foam allows the intrusion of water over time. The closed-cell structure of Styrofoam™ Brand XPS Insulation resists water intrusion, making it the design choice for roofs that withstand the elements and the test of time.



### Moisture

XPS structure absorbs significantly less water than EPS products.



### Durability

Absorbed water can cause damage in freeze/thaw conditions.



### R-value

XPS maintains R-value better than EPS when water is present.<sup>1</sup>

<sup>1</sup>Billy Connor, April 2019. "Comparison of Polystyrene Expanded and Extruded Foam Insulation in Roadway and Airport Embankments". Alaska University Transportation Center, University of Alaska Fairbanks, (INE/AUTC 19.08). <https://ajdc.uaf.edu/projects/2019/comparison-of-polystyrene-expanded-and-extruded-foam-insulation-in-roadway-and-airport-embankments/>

# Protected membrane roofs

A protected membrane roof (also known as an inverted roof or upside-down roof) uses the same materials as a conventional roof but places the insulation on top of the waterproofing membrane. Insulation boards are loose-laid over the membrane and then weighted down with gravel ballast, paving slabs, or soil in the case of “green” or vegetative roofs.

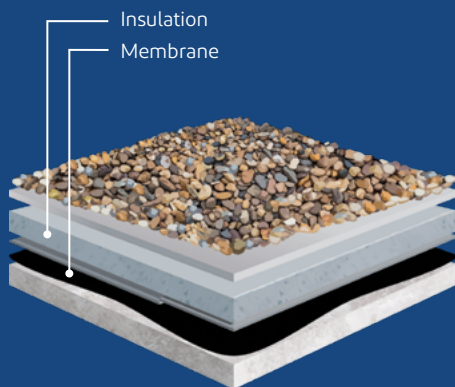

Inverted roofs are becoming a popular alternative to conventional roofs because they are cost-efficient and energy-saving, improve occupant satisfaction, provide long-term performance and sustainability benefits, and increase community resilience.

**DuPont™ Styrofoam™ Brand Roofmate™, Plazamate™ and Highload XR XPS Insulation** products are ideal for insulating a wide range of protected membrane roof assemblies because they are inherently resistant to moisture and durable enough to withstand prolonged exposure to surface traffic and the environment.

## Proven products<sup>†</sup> for protected membrane roofs

**DuPont™ Styrofoam™ Brand Roofmate™ XPS Insulation** provides excellent moisture resistance, durability and long-term R-value.

**DuPont™ Styrofoam™ Brand Plazamate™ XR XPS Insulation** is high-density insulation board for use in plaza deck applications – providing 30% higher r-value per inch.

**DuPont™ Styrofoam™ Brand Highload 40, 60 and 100 XPS Insulation** features high compressive strength; well-suited for plaza decks and PMRs that must withstand heavy traffic.

**DuPont™ Froth-Pak™ Insulation** is a two-component spray foam for filling larger cavities; provides insulating as well as air-sealing qualities.

<sup>†</sup>For HFC-regulated U.S. states, products are transitioning to a new Styrofoam™ Brand ST-100 Series (e.g., Styrofoam™ Brand Plazamate™ XPS Insulation will transition to Styrofoam™ Brand Plazamate™ ST-100 XPS Insulation). Visit [beyondblue.dupont.com](http://beyondblue.dupont.com) for details.

## Typical protected membrane roof assemblies

### Stone ballasted roof

Durable. Energy-efficient. Economical. Fast and easy to install.

#### Stone ballasted roof assembly

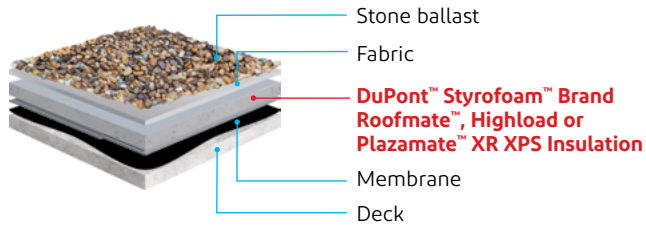

### Paver roof

Durable. Energy-efficient. Adds rooftop recreation space.

#### Paver roof assembly

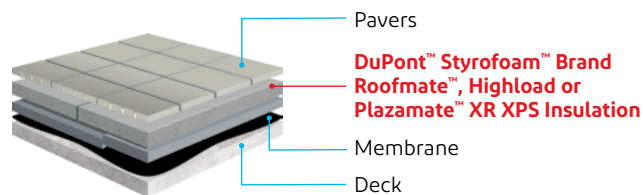

#### Paver on pedestal roof assembly

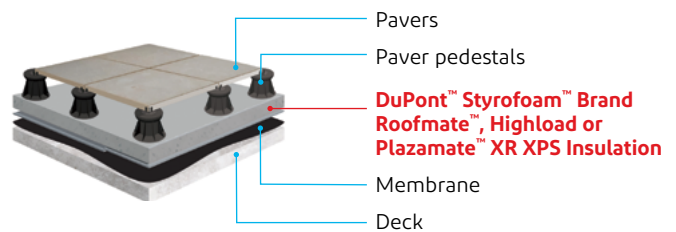

### Green roof

Lowers cooling costs. Reduces stormwater runoff. Promotes biodiversity. Improves air quality.

#### Extensive green roof assembly

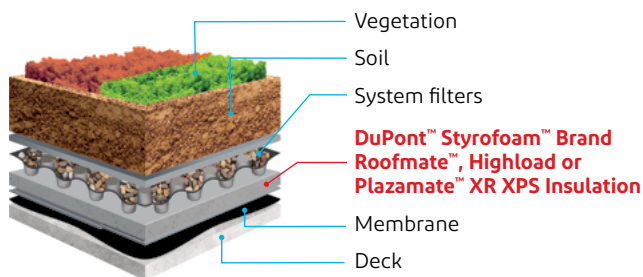

#### Intensive green roof assembly

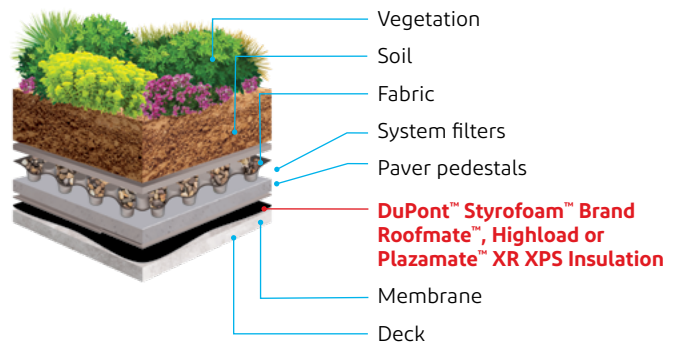

### Blue roof

Storm water management. Lateral drainage. Irrigation. Blends well with green roofs.

#### Paver blue roof assembly

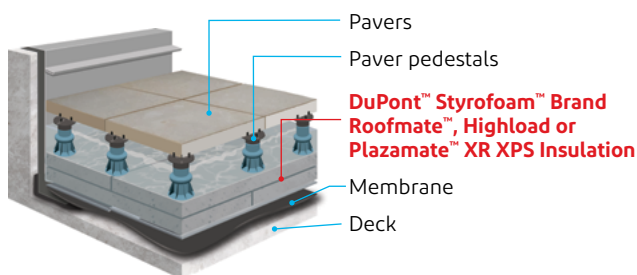

#### "Green" blue roof assembly

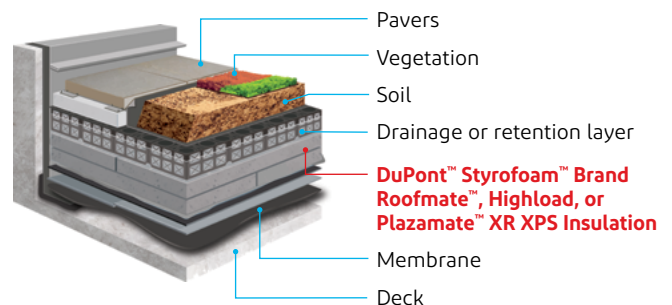

# Conventional roofs

In conventional roofs, the waterproofing membrane is positioned on top of the insulation.

DuPont™ Styrofoam™ Brand Square Edge and Deckmate™ Plus products are designed specifically for use in conventional flat and low-slope roofs. They help your roof resist the elements easily and economically with their direct-to-deck application and ability to deliver thermal performance without the need for a separate thermal barrier.

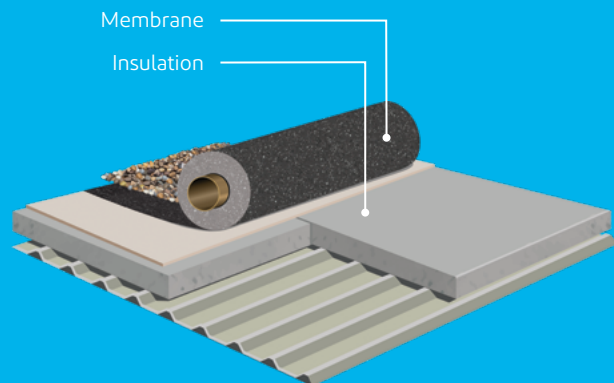

# Typical conventional roof assembly

## Single-ply roof

Lightweight. Flexible. Cost-effective. Quick to install.

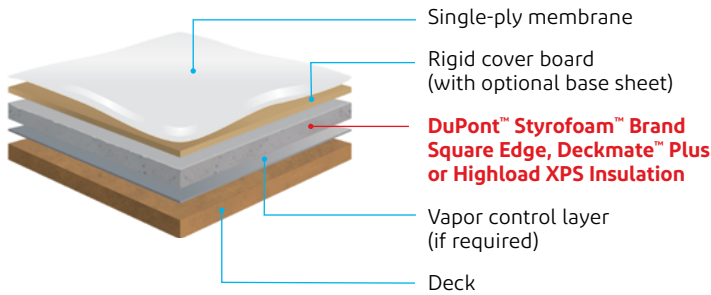

## Proven products<sup>†</sup> for mechanically attached or adhered conventional roofs

**DuPont™ Styrofoam™ Brand Square Edge and Deckmate™ Plus XPS Insulation** are designed for use in fully adhered and mechanically attached low-slope roof applications.<sup>‡</sup>

**DuPont™ Styrofoam™ Brand Deckmate™ Plus XPS Insulation** is designed to provide higher compressive strength and membrane support.

**DuPont™ Styrofoam™ Brand Square Edge** feature a planed surface for excellent bonding of adhesive and square or shiplap edges for a tight fit.

**DuPont™ Styrofoam™ Brand Highload 40, 60 and 100 XPS Insulation** features high compressive strength.

**DuPont™ Styrofoam™ Brand Highload 40, 60 and 100 Tapered XPS Insulation** provides a positive slope to improve roof drainage.

**DuPont™ Insta Stik™ Quik Set Commercial Roofing Adhesive** is for adhering the insulation to the roofing deck and coverboard without need for fasteners.

**DuPont™ Tile Bond™ Roof Tile Adhesive** is a minimally expanding foam for clay and concrete roof tiles.

**DuPont™ Froth-Pak™ Insulation** is a two-component spray foam for filling larger cavities; provides insulating as well as air-sealing qualities.

<sup>†</sup> For HFC-regulated U.S. states, products are transitioning to a new Styrofoam™ Brand ST-100 Series (e.g., Styrofoam™ Brand Deckmate™ Plus XPS Insulation will transition to Styrofoam™ Brand Deckmate™ Plus ST-100 XPS Insulation). Visit [beyondblue.dupont.com](http://beyondblue.dupont.com) for details.

<sup>‡</sup> Available in Canada.

## DuPont™ Styrofoam™ Brand Extruded Polystyrene (XPS) Insulation products

Properties	Thermal resistance <sup>(1,2)</sup> aged R-value per inch @ 75°F mean temp	Compressive strength, minimum, lb/in <sup>2</sup> (3)	Flexural strength, minimum, lb/in <sup>2</sup>	Water absorption, maximum, % by volume	Water vapor permeance <sup>(4)</sup> , maximum, perm	Dimensional stability, maximum, % linear change	Coefficient of linear thermal expansion, x10 <sup>-5</sup> in/in·°F	Applicable standards	Maximum use temperature, °F	Flame spread <sup>(6)</sup>	Smoke developed	Width, in	Length, in	Typical thickness range, in
ASTM method	C518	D1621	C203	C272	E96	D2126				E84	E84			
DuPont™ Styrofoam™ Brand Square Edge (Flat and Tapered)	5.0	25	50	0.1	1.5	2.0	3.5	ASTM C578, Type IV <sup>(5)</sup>	165	15	165	24	96	1/2 to 1.5 slopes 1, 1.5, 2, 3 fill
DuPont™ Styrofoam™ Brand Plazamate XR™	6.7	60	75	0.01	0.2	0.9	3.5	ASTM C578, Type VII <sup>(5)</sup>	165	20	50	48	96	2.3, 3.0
DuPont™ Styrofoam™ Brand Plazamate XPS™	5.0	60	75	0.1	0.8	2.0	3.5	ASTM C578, Type VII <sup>(5)</sup>	165	15	165	24	96	2.0, 3.0
DuPont™ Styrofoam™ Brand Roofmate™	5.0	40	60	0.1	1.0	2.0	3.5	ASTM C578, Type VI <sup>(5)</sup>	165	15	165	24	96	1.0, 1.5, 2.0, 2.5, 3.0, 3.5, 4.0
DuPont™ Styrofoam™ Brand Highload 40 (Flat and Tapered)	5.0	40	60	0.1	1.0	2.0	3.5	ASTM C578, Type VI <sup>(5)</sup>	165	15	165	24 48	96	2.0, 3.0 1/8", 1/4", 1/2" slopes
DuPont™ Styrofoam™ Brand Highload 60 (Flat and Tapered)	5.0	60	75	0.1	0.8	2.0	3.5	ASTM C578, Type VII <sup>(5)</sup>	165	15	165	24	96	2.0, 3.0 1/8", 1/4", 1/2" slopes
DuPont™ Styrofoam™ Brand Highload 100 (Flat and Tapered)	5.0	100	100	0.1	0.8	2.0	3.5	ASTM C578, Type V <sup>(5)</sup>	165	15	165	24	96	2.0 1/8", 1/4", 1/2" slopes
DuPont™ Styrofoam™ Brand Deckmate™ Plus (Flat and Tapered)	5.0	25	50	0.1	1.5	2.0	3.5	ASTM C578, Type IV <sup>(5)</sup>	165	15	165	24	96	1.5, 2.0, 2.5, 3.0, 4.0 1/8", 1/4", 1/2" slopes

\*These are typical physical properties. Not to be construed as sales specifications.

<sup>(1)</sup> Values are consistent with the criteria of ASTM C578 and the requirements of the FTC R-value rule (16 CFR Part 460). A 15-year limited thermal warranty is available.

<sup>(2)</sup> R means resistance to heat flow. The higher the R-value, the greater the insulating power. R-values are expressed in ft<sup>2</sup>·h·°F/Btu.

<sup>(3)</sup> Vertical compressive strength is measured at 10% deformation (5% for DuPont™ Styrofoam™ Brand Plazamate™ Insulation and for DuPont™ Styrofoam™ Brand Highload 40, 60 and 100 Insulation) or at yield, whichever occurs first. Because DuPont™ Styrofoam™ Brand Extruded Polystyrene Foam Insulation is a viscoelastic material, adequate design safety factors should be used to prevent long-term creep and fatigue deformation. For static loads, 3:1 is suggested. For dynamic loads, 5:1 is suggested.

<sup>(4)</sup> Water vapor permeance varies with product type and thickness. Values are based on the desiccant method, and they apply to insulation 1" in thickness. Thicker products have lower permeance.

<sup>(5)</sup> Former Federal Specification HH-I-524C was canceled in 1985 and replaced by ASTM C578.

<sup>(6)</sup> This numerical flame spread rating is not intended to reflect hazards presented by this or any other material under actual fire conditions.

<sup>(7)</sup> For Styrofoam™ Deckmate™ Plus FA specifications, please contact your local sales representative regarding custom order requirements.

**Note:** For a more complete list of available Styrofoam™ Brand roofing products, visit [building.dupont.com/commercial](http://building.dupont.com/commercial) (U.S. products) or [building.dupont.ca/commercial](http://building.dupont.ca/commercial) (Canadian products).

Not all products are available in all parts of the country. Other product sizes are available on a made-to-order basis. Contact your DuPont representative with questions.

## Build Up – Confidence.

**Expert support** – With comprehensive design, application and installation assistance, our team of building science experts can support your project from the ground up.

**Custom tapered design consultation service** – DuPont™ Styrofoam™ Brand Tapered XPS Insulation products provide a positive slope to improve roof drainage. Send us your drawings, and we'll provide a custom quote for your design. We can help you with installation requirements, and our custom fabricators provide exceptional service. Contact DuPont Customer Care or your local DuPont Performance Building Solutions representative for assistance.

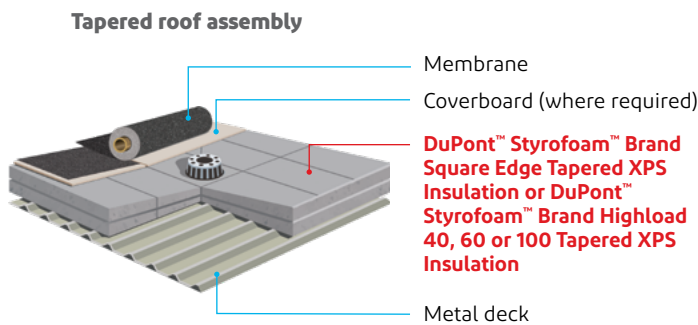

**Warranty protection from a name you can trust** – In the U.S., a 50-year thermal limited warranty is available from DuPont on Styrofoam™ Brand Insulation products 1.5 inches and greater. Additionally, Styrofoam™ Brand Square Edge and Deckmate™ Plus Insulation products 1.5 inches and greater are eligible for a limited 50-year reuse warranty when used in conventional roofing applications. For thickness less than 1.5 inches, other warranties may apply. Visit [building.dupont.com/warranties](https://building.dupont.com/warranties) or contact your DuPont Performance Building Solutions representative for details.



[building.dupont.com](https://building.dupont.com)

## Protection for all six sides

**The future of building begins now**, and DuPont Performance Building Solutions is committed to being in step with where you and the construction industry are going. Our robust portfolio of proven and compatible products brings together decades of technology, experience and innovation to provide water, air and thermal protection for all six sides of your building envelope – from the foundation and walls to the roof and the transitions in between.



And it's all backed by warranties from a name you can trust, plus the expertise and support of building science leaders who are dedicated to your success.

*Build up trust.*  
*Build up confidence.*  
*Build up opportunity with DuPont.*

## Learn more

Detailed product information, installation guidance and learning resources – as well as complete submittal resources – are available online.

[building.dupont.com](https://building.dupont.com)

Contact your local DuPont Performance Building Solutions representative for more information.

**DuPont Customer Care**  
1-833-338-7668

No freedom from infringement of any patent or trademark owned by DuPont or others is to be inferred. Because use conditions and applicable laws may differ from one location to another and may change with time, Customer is responsible for determining whether products and the information in this document are appropriate for Customer's use and for ensuring that Customer's workplace and disposal practices are in compliance with applicable laws and other government enactments. The product shown in this literature may not be available for sale and/or available in all geographies where DuPont is represented. The claims made may not have been approved for use in all countries. DuPont assumes no obligation or liability for the information in this document. References to "DuPont" or the "Company" mean the DuPont legal entity selling the products to Customer unless otherwise expressly noted. NO WARRANTIES ARE GIVEN; ALL IMPLIED WARRANTIES OF MERCHANTABILITY OR FITNESS FOR A PARTICULAR PURPOSE ARE EXPRESSLY EXCLUDED.

DuPont™, the DuPont Oval Logo, and all trademarks and service marks denoted with ™, SM or ® are owned by affiliates of DuPont de Nemours, Inc. unless otherwise noted. © 2023 DuPont.